

22 513 892



- sporgenza 165 mm
- bocca girevole 360°
- Getto circolare con aria
- altezza rubinetteria 295 mm
- altezza fino al rompigitto 172 mm
- diametro foro 35 mm
- rosetta Ø 59 mm
- 2x tubo flessibile di mandata M 10 x 1 avvitato, tenuta controllata
- portata max 7 l/min
- senza piombo
- Questo prodotto può aiutare un edificio a soddisfare i requisiti dei Green Building Rating Systems, ad es. LEED®, BREEAM®, DGNB

Solamente per lavabo con troppopieno.

	Cromo spazzolato	22 513 892-93
	Cromato	22 513 892-00
	Platinato spazzolato	22 513 892-06
	Platinato	22 513 892-08
	Dark Chrome	22 513 892-19
	Ottone spazzolato (Oro 23k)	22 513 892-28
	Nero opaco	22 513 892-33
	Champagne spazzolato (Oro 22k)	22 513 892-46
	Champagne (Oro 22k)	22 513 892-47
	Dark Platinum spazzolato	22 513 892-99

22 513 892

mm [inches]



Diagramma di portata



Certificati

ETA_18512.

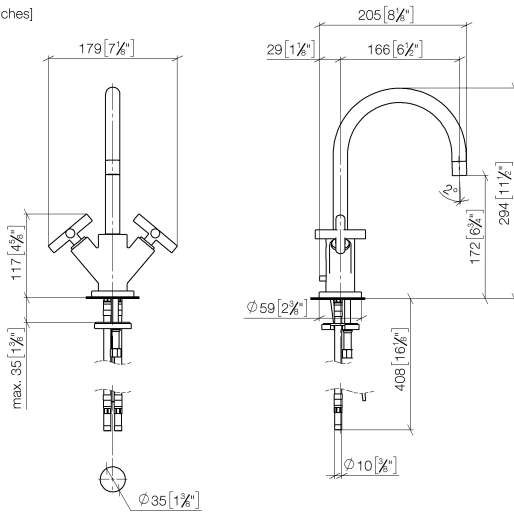
WRAS_1810003.

LGA_18920.

GDV_0400194.

22 513 892

Parts for other
finishes can be found
here: Cromato

